

MAHDI AND MAHDIYA ASK ABOUT THE MONTH OF RAMADHAN

"Pappa look, I can see the moon!" said Mahdi excitedly, pointing at the sky.

"Where is it, I can't see it, please show me" asked Mahdiya, searching the sky.

"There it is Mahdiya," showed her father, "it's a very thin crescent. Did you see it?"

"Oh yes! There it is!" exclaimed Mahdiya.

"Mashallah, it looks so beautiful. And it also marks the beginning of a glorious month, the Holy month of Ramadhan! Let us recite the Dua which has to be recited upon sighting the new moon of Ramadhan".

In the name of Allah the Beneficent the Merciful
My Lord and your Lord is Allah,
Lord of the worlds
O Allah let the new moon bring us,
peace and faith, safety and submission and a
hastening towards
what You like and
are pleased with.

O Allah bless us
in this month of
ours, and give us
of its good, and
its assistance
Keep us away from
its harm, and its
evil, its difficulties,
and its trials.



بِسْمِ اللَّهِ الرَّحْمَنِ الرَّحِيمِ
رَبِّي وَرَبُّكَ اللَّهُ رَبُّ الْعَالَمِينَ
اللَّهُمَّ أَهْلُهُ عَلَيْنَا بِالْأَمْنِ وَالْإِيمَانِ
وَالسَّلَامَةِ وَالْإِسْلَامِ
وَالْمُسَارَعَةِ إِلَى مَا تُحِبُّ وَتَرْضَى

اللَّهُمَّ بَارِكْ لَنَا فِي شَهْرِنَا هَذَا
وَارْزُقْنَا خَيْرَهُ وَعَوْنَهُ
وَأَصْرِفْ عَنَّا ضَرَّهُ وَشَرَّهُ
وَبَلَاءَهُ وَفِتْنَتَهُ
وَبَلَاءَهُ وَفِتْنَتَهُ

Mahdi and Mahdiya wanted to know more about the month of Ramadhan. So they listen to their father as he tells them about Ramadhan.

"Ramadhan is the 9th month in the Islamic calendar. This is the month that is the best of all months in the eyes of Allah. It is a month full of His blessings and mercies.

This is a month in which you have been invited by Him. You have been given the opportunity in this month to receive the honors from Allah, the Merciful.

Also the Holy Qur'an was sent down to Prophet Muhammed(s.a.w.w) in this blessed month.

In this month Allah has ordained us to FAST. This means we have to stay away from food and drink and sinful actions from sunrise to sunset. It is a great test for us as it teaches us how it feels to be poor and hungry. The food we eat when we break our fast at sunset is called 'IFTAAR'."

"Do Mahdiya and I have to fast too?" asked Mahdi.

"Well, you don't have to until you become 'Baaligh', which is 9years for girls and about 15years for boys. But you can try fasting sometimes, it is not always easy. We can get tired, hungry and thirsty."

"But pappa, how will I get a lot of Thawaab if I don't fast?" asked Mahdiya.

Mahdi and Mahdiya's father explains how there are other ways of getting closer to Allah and receive His blessings.

Dua to be recited before breaking the fast:

O Allah for You we fast and on what you provide we break our fast, so accept from us; Indeed You are all Hearing, all knowing.

بِسْمِ اللّٰهِ الرَّحْمٰنِ الرَّحِیْمِ اَللّٰهُمَّ لَكَ صَمْنَا وَعَلَيْ رِزْقِكَ اَفْطَرْنَا،

فَتَقَبَّلْ مِنَّا، اِنَّكَ اَنْتَ السَّمِیْعُ الْعَلِیْمُ

Du'aa upon Sighting the New Moon



اللَّهُمَّ أَهْلَهُ عَلَيْنَا بِالْإِيمَانِ وَالسَّلَامَةِ
وَالْإِسْلَامِ وَالتَّوْفِيقِ لِمَا تُحِبُّ وَتَرْضَى
رَبِّي وَرَبُّكَ اللَّهُ

"O Allah, let this moon (month) pass over us with blessings,
Iman, safety, and in the belief of Islam. Grant us the ability to
act on the actions that You love and Pleases You. (O moon)
My Lord and Your Lord is Allah."

(At-Tirmidhi no. 3451)

**COLOR THE PICTURES BELOW OF THE OTHER
ACTIONS WHICH CAN BRING YOU
CLOSER TO ALLAH (s.w.t)**

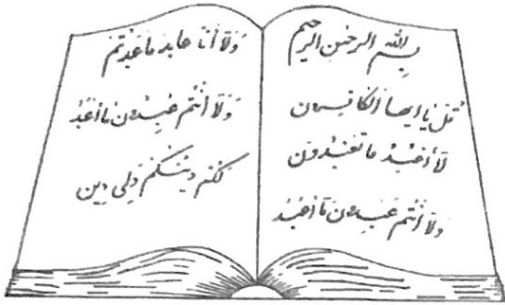

Reciting the Holy Qur'an

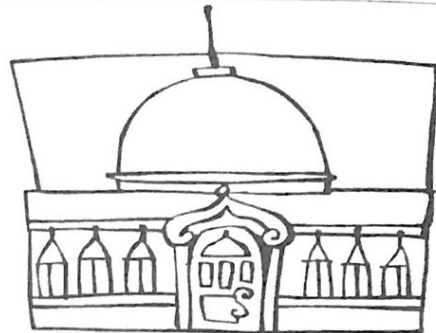

Attend the mosque regularly



**Give charity to the
poor and needy(sadqa)**



Forgive others of their mistakes



**Help your parents at
home and listen to them**



**Get closer to Allah
by reciting Du'as**



**Guard your tongue from being
mean, saying lies, backbiting**



**Treat other children and
relatives with kindness**

PUT AN X ON ALL THE THINGS NOT ALLOWED
WHILST FASTING.

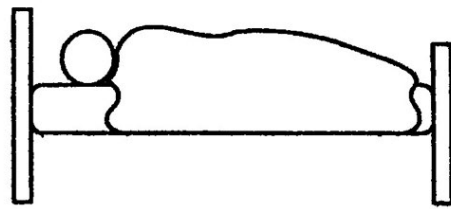
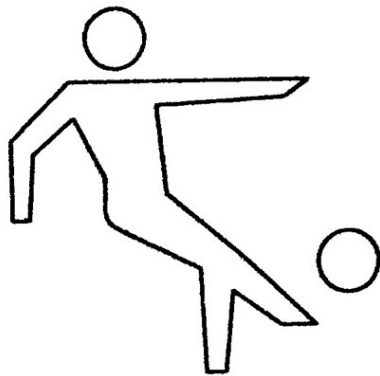
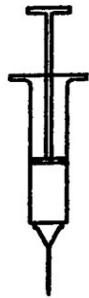
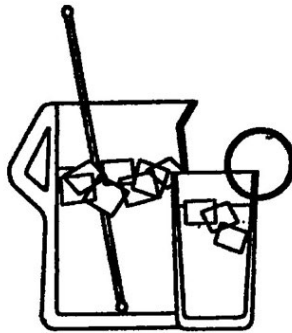
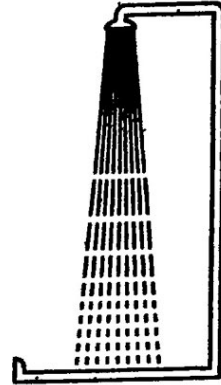
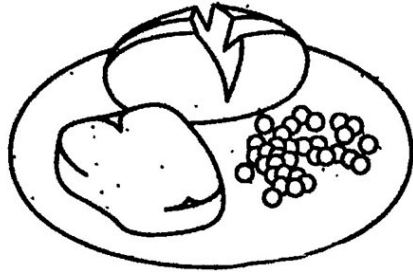

RAMADHAN

CHART



Write down your good deeds for each day. e.g. reciting the Holy Qur'an, praying namaaz, fasting, giving money to the needy, being kind to others, making new friends, helping out at home etc. These are just a few examples, I am sure you can think of many more.

1 Ramadhan	
2 Ramadhan	
3 Ramadhan	
4 Ramadhan	
5 Ramadhan	
6 Ramadhan	
7 Ramadhan	
8 Ramadhan	
9 Ramadhan	
10 Ramadhan	
11 Ramadhan	
12 Ramadhan	
13 Ramadhan	
14 Ramadhan	
15 Ramadhan	
16 Ramadhan	
17 Ramadhan	
18 Ramadhan	
19 Ramadhan	
20 Ramadhan	
21 Ramadhan	
22 Ramadhan	
23 Ramadhan	
24 Ramadhan	
25 Ramadhan	
26 Ramadhan	
27 Ramadhan	
28 Ramadhan	
29 Ramadhan	
30 Ramadhan	

CATCH THE FISH WHICH HAVE THE GOOD MANNERS AT THE MOSQUE

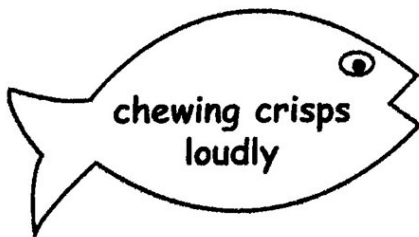
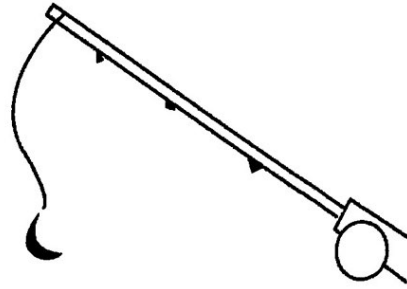

MAHDI AND MAHDIYA LEARN ABOUT BIBI KHADIJAH



When the 10th of Ramadhan arrived, Mahdi and Mahdiya wore their black clothes to the mosque.

This was because it was the 'wafaat' of **Bibi Khadijah**.

Who was Bibi Khadijah?

Here's what Mahdi and Mahdiya learnt about Bibi Khadijah after listening to the lecture at the mosque.

Bibi Khadijah was a very rich woman in Makka and used to own many caravans and take care of the family business. She used to be known as '**the Princess of Makka**'.

With the wealth she had, she helped the poor, the widows, the sick and the orphans of Makka.

Because of her excellent Akhlaq, the Arabs gave her the title '**Tahira**' - **the pure one**.

Many Arab men wanted to marry her but she refused all of them.

Then once there came a time where Bibi Khadijah was looking for someone to take charge of her caravan. Hazrat Abu Talib, the Holy Prophet's uncle, suggested Prophet Muhammed(s.a.w.w.).

The trading caravan was a huge success. Bibi Khadijah was very impressed with Prophet Muhammed's character and asked him to marry her. The marriage was a very happy one.

Their first child was a son called Qassim and the second was Abdullah. Both of them died very young.

Their third and last child was Bibi Fatima (a.s).

Bibi Khadijah was the first woman to accept Islam and support the Holy Prophet(s.a.w.w). She gave all her wealth for the sake of Islam, which helped the Muslims survive for a long time.

Then in 619 AD, on the 10th of Ramadhan she left this world. The Holy Prophet(s.a.w.w) was very sad after she died as he loved her very much. Hazrat Abu Talib died in this year too and so the Holy Prophet(s.a.w.w) called it '**Aamul Huzn**' - the year of sorrow.



JOIN THE TRAIN TO IT'S RIGHT CARRIAGE BY
JOINING THE SENTENCES CORRECTLY.
THEN COLOR THEM IN

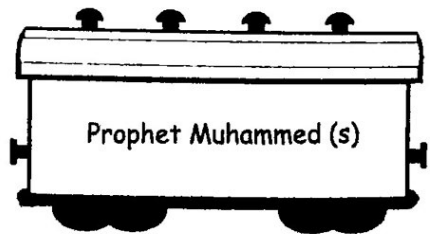
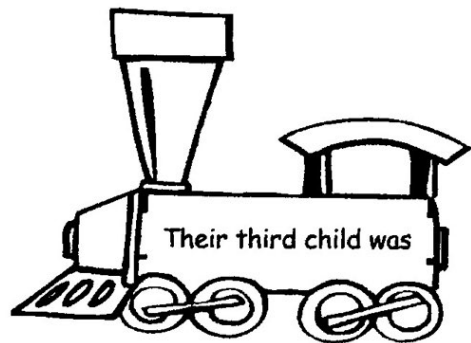
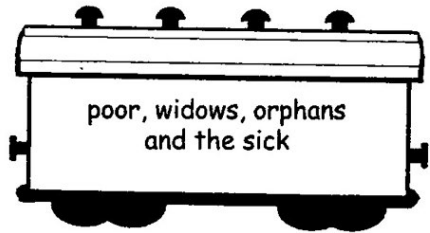
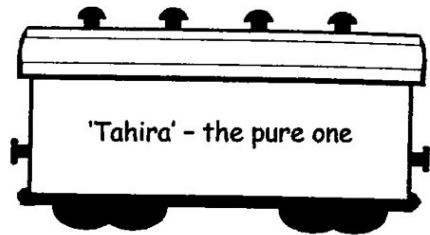
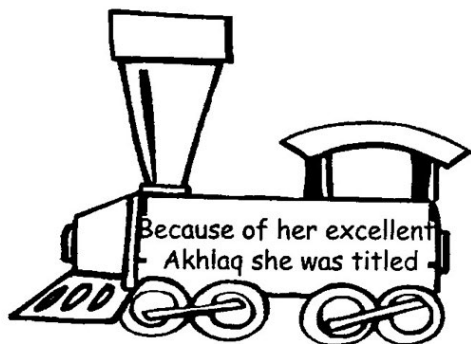
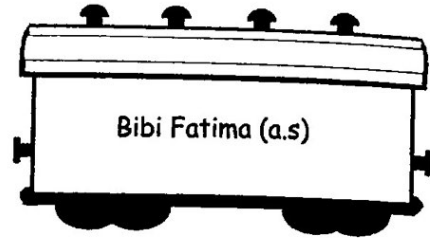
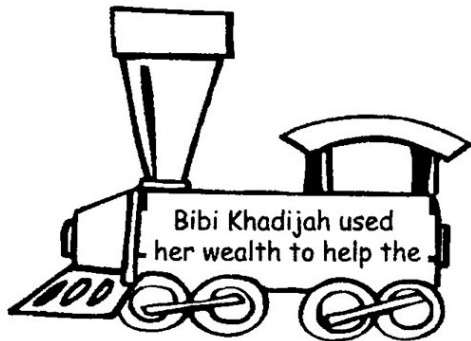



O' IMAM HASSAN, WE WISH YOU A VERY HAPPY BIRTHDAY!

It is the 15th of Ramadhan and Mahdi and Mahdiya are in the kitchen today. Do you know what they are making?
Yes! They are making cupcakes and icing them too!
But what is so special about today? Whose birthday is it?



Today Mahdi and Mahdiya are celebrating the birthday of our 2nd Imam, Imam Hassan(a.s).

Imam Hassan(a.s) was born on Tuesday the 15th of Ramadhan 3A.H in Medina to Imam Ali(a.s) and Bibi Fatema(a.s).
Imam Hassan(a.s) was the first grandchild of the Holy Prophet(s.a.w.w) and this was a very happy day for the Holy Prophet(s.a.w.w).

On behalf of Almighty Allah, the Holy Prophet(s.a.w.w) named him 'Hassan'. The title he was given was 'Al Mujtaba', meaning 'the chosen one'.

Imam Hassan(a.s) had the perfect manners and was even polite to those who were rude to him.

Once a follower of the evil man Muawiya came from Syria to Medina and started to shout at the Imam and use bad language.
Imam Hassan(a.s) listened quietly. When the man finished talking, Imam then greeted the man and invited him back to his house for food and rest as he had come from a long trip.
When the man saw the perfect manners of Imam Hassan(a.s), he was very ashamed and realized how wrong he was, and asked for forgiveness from the Imam.

We learn from Imam Hassan(a.s) that we should always have good manners no matter how other people act towards us. Also we should not blindly believe bad things you hear about people.

Imam Hassan(a.s) was poisoned by one of his wives called Jo'da, who was bribed by Muawiya. Imam is buried in Jannat ul Baqi in Medina.

LESSONS WE LEARN FROM IMAM HASSAN(a.s)

Mahdi and Mahdiya are trying not to use abusive words and having good manners like Imam Hassan(a.s).

Help them by drawing a heart around the nice words and putting a cross on the abusive words.

UGLY

SORRY

THANKYOU

NAUGHTY



HORRIBLE

PLEASE

YUCK

MASHALLAH

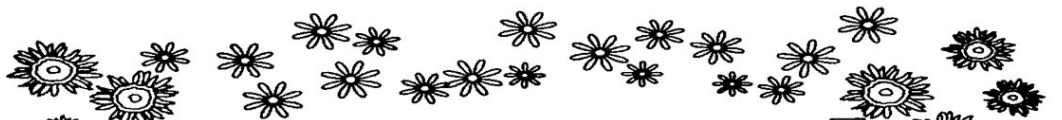
COLOR IN THE FOLLOWING HADITH

Hasan and
Husayn are
the leaders
of the youths
of paradise.

RECOGNIZING QUR'ANIC ALPHABETS

Color the letters according to the key given below:

- letters with ONE NUQTA(DOT) - color in red
- letters with TWO NUQTA(DOTS) - color in blue
- letters with THREE NUQTA(DOTS) - color in green
- letters with NO NUQTA(DOTS) - color in yellow

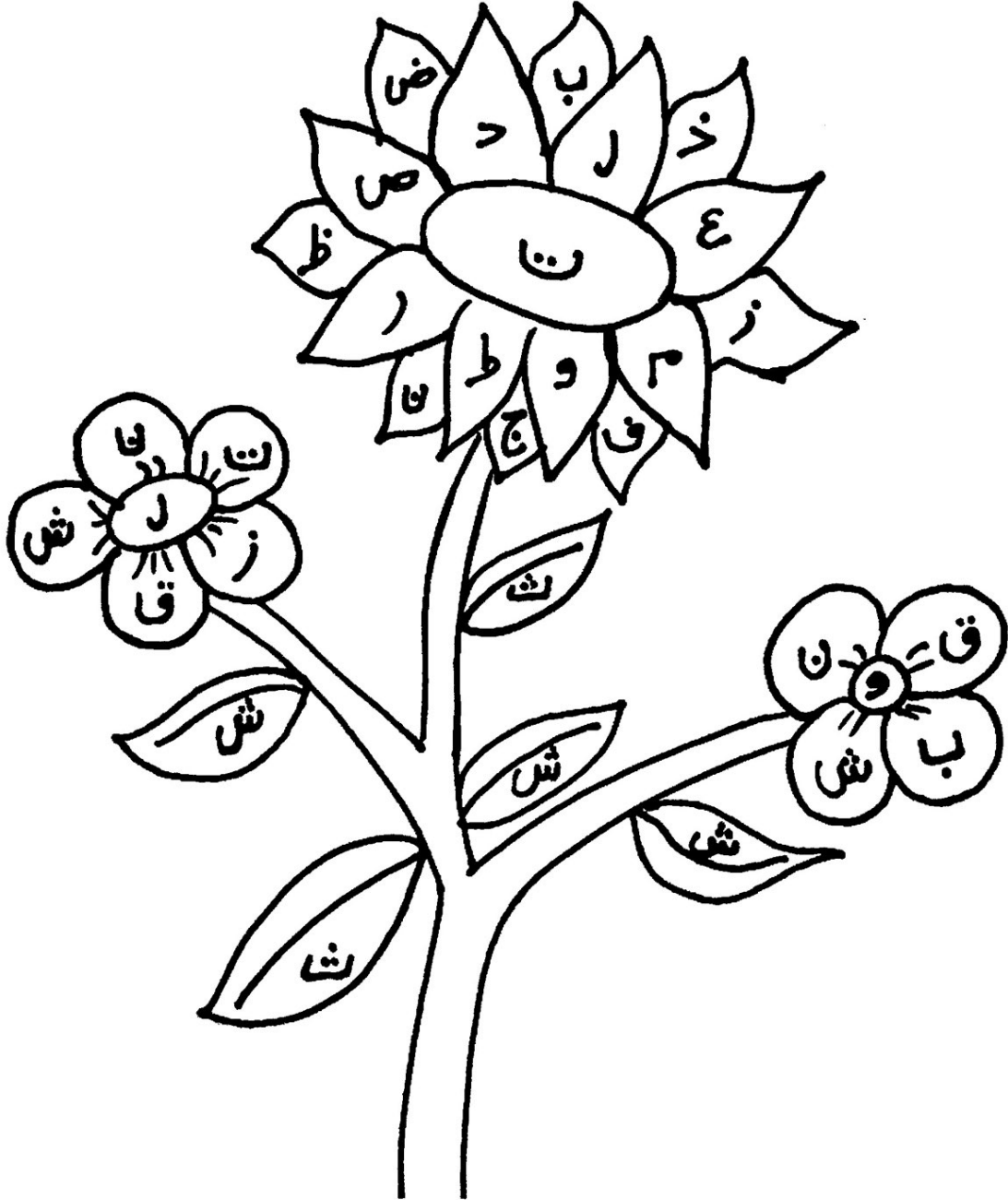

PROPHET MUHAMMAD (S) SAID:
“ANGELS VISIT THE HOUSE IN WHICH THE
QURAN IS RECITED”

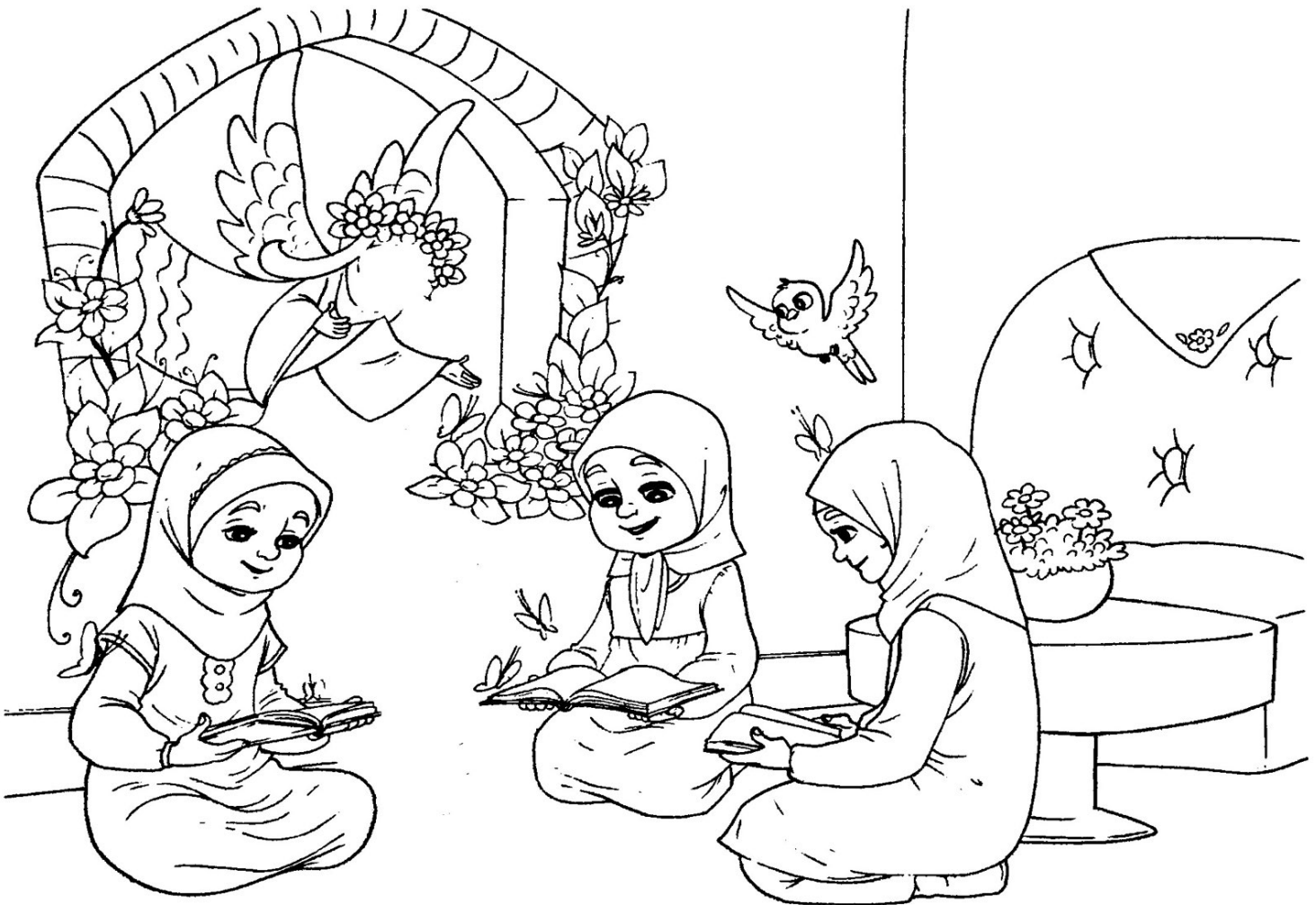

THE 19th, 20th AND 21ST OF RAMADHAN - THREE VERY SAD DAYS IN THIS HOLY MONTH

"Mummy, can you please tell us about why these three nights of Ramadhan are very sad?" asked Mahdi, as they all sat down to have their Iftar.

"Well children, do you know who our 1st Imam is?"

"Imam Ali(a.s)!" replied Mahdiya quickly.

"And what do you know about him?" asked their mother.



Mahdi and Mahdiya told their mother what they knew about Imam Ali(a.s). This is what they knew:

- Imam Ali(a.s) was the son of Hazrat Abu Talib and cousin of the Holy Prophet(s.a.w.w) and was brought up by him.
- He was the only person to be born in the Holy Ka'aba.
- He was the first man to believe and accept the Holy Prophet's message about Islam and was his successor.
- Imam Ali(a.s) married the Holy Prophet's daughter Bibi Fatema(a.s) and they had two sons - Imam Hassan(a.s), Imam Husayn(a.s) and two daughters - Bibi Zainab and Umm Kulthum.

"That's all true children," said their mother, "well, on the 19th of Ramadhan, Imam Ali(a.s), our first Imam, left home to go to the mosque for his morning prayers.

As he arrived in the mosque, he awoke all those who were sleeping including a man called Abdur Rahman bin Muljim.

Imam then gave Adhaan and began to lead the prayers. When Imam went for Sajda, Ibne Muljim struck Imam Ali on the head with a poisonous sword, and this caused a deep wound on Imam Ali's head. He finished his second Sajda saying "Fuztu Birabbil Ka'aba" (I have been successful with the Lord of the Ka'aba), and then asked his son Imam Hassan to finish the prayer.

Imam Ali died two days later on the 21st of Ramadhan. That is why all three days are very sad. A very great person in the eyes of Allah and a lesson to mankind passed away."

Mahdi and Mahdiya then performed ghusl and put on their black clothes, ready to go for the special Aamaal at the mosque.

FILL IN THE APPLES WITH THE MISSING NAMES OF THE FAMILY OF IMAM ALI

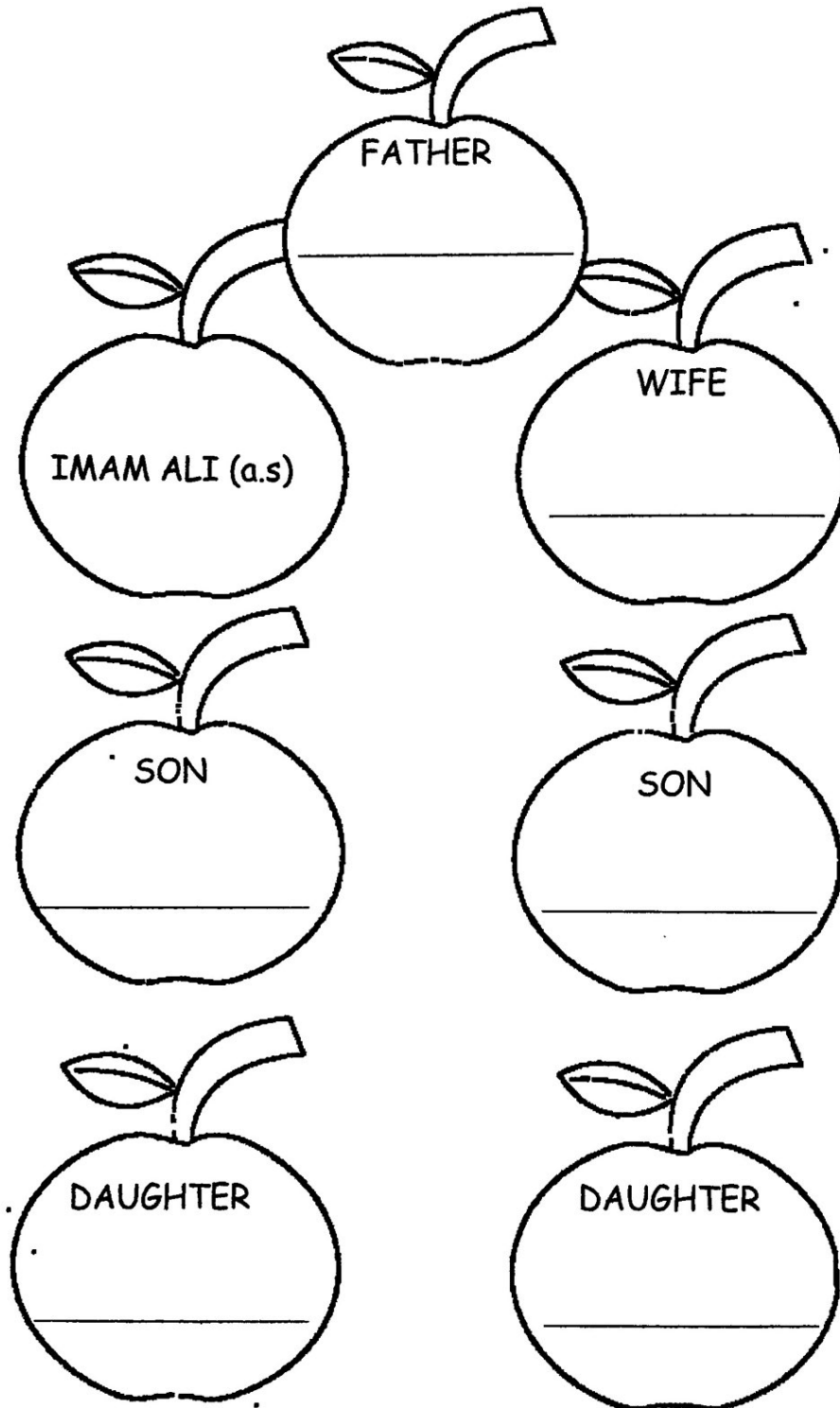

**COLOR IN THE HOLY SHRINE OF
IMAM ALI(a.s) IN NAJAF**

YA ALI

يا علي

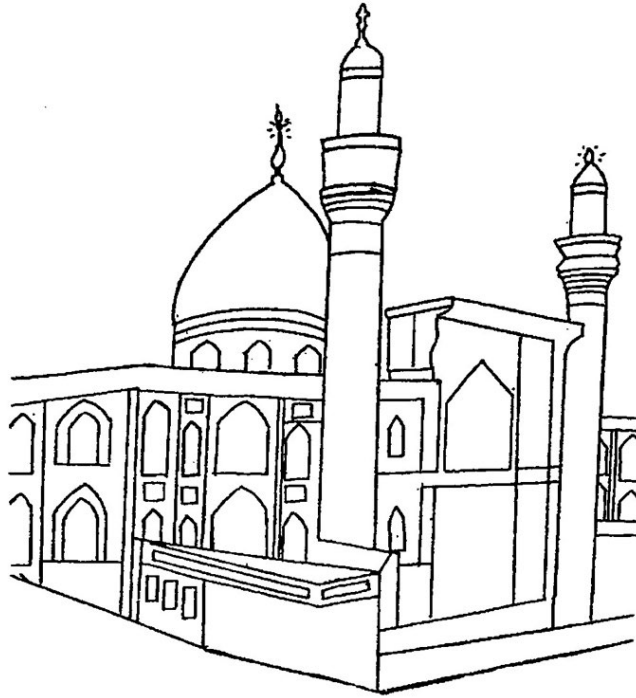

**JOIN THE DOTS TO COMPLETE THE SWORD OF
IMAM ALI CALLED 'ZULFIQAR'.**

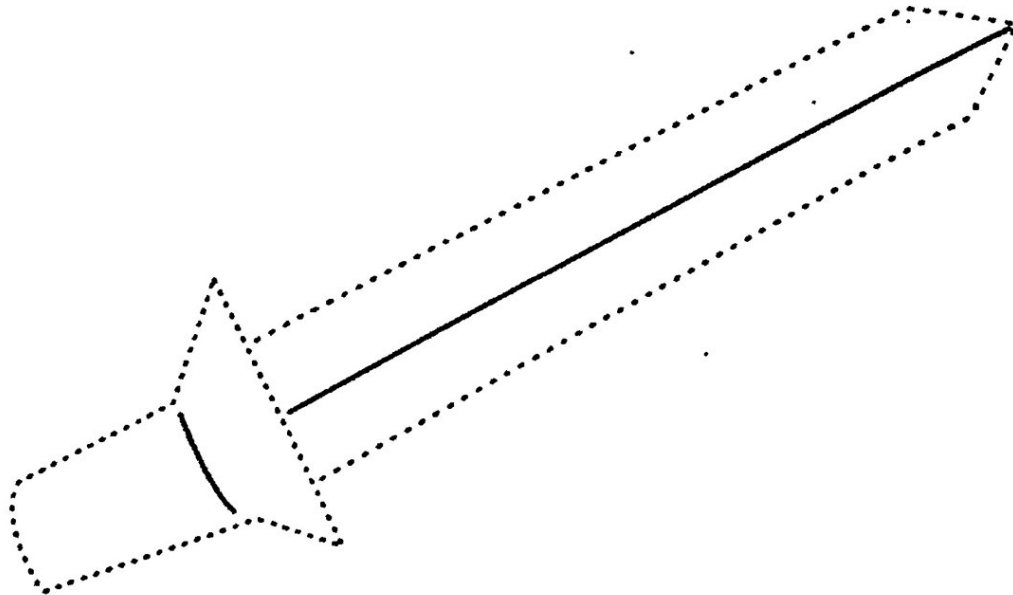

MAHDI AND MAHDIYA PREPARE THEMSELVES FOR THE NIGHT OF QADR (LAYLAT-UL-QADR)

"Mahdi, Mahdiya, have you had your ghusl?" asked their mother. "Yes mummy, we are all ready now", replied Mahdi and Mahdiya together.

Mahdi looks very good in his white kandura, and Mahdiya is wearing a beautiful white shalwaar kameez. They are ready for this great night.

But why is this night so special? Tonight is the 23rd night of Ramadhan. It is known as 'the night of Qadr'.

It is on this night that the Holy Qur'an, the greatest miracle ever witnessed by mankind, was brought down to the Holy Prophet.

Just like we are happy and celebrate when a baby is born, Laylatul Qadr is celebrated as it brings light and guidance to mankind.

On a birthday, we celebrate with lots of food and games, but on Laylatul Qadr we celebrate by reciting lots of Du'a and prayers.

Angels come down from the heavens to bring us special blessings and peace from Allah and whoever prays to Allah for forgiveness on this night, their sins shall be forgiven.

Our destiny is also decided on this special night.

There is a short Surah talking about the night of Qadr called Suratul Qadr. Let us all learn it.



SURAH QADR

بِسْمِ اللَّهِ الرَّحْمَنِ الرَّحِيمِ

وَمَا أَدْرَاكَ مَا لَيْلَةُ الْقَدْرِ

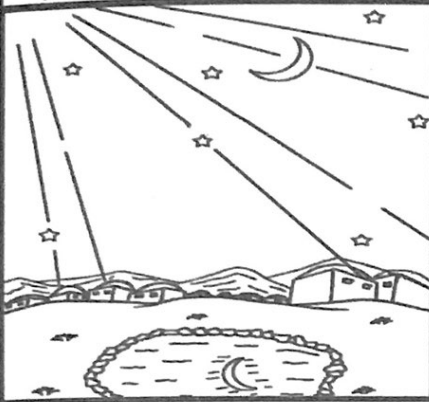

And what shall teach thee
what is the Night of Power?

إِنَّا أَنْزَلْنَاهُ فِي لَيْلَةِ الْقَدْرِ



Behold, We sent it down
on the Night of Power

لَيْلَةُ الْقَدْرِ خَيْرٌ مِّنْ أَلْفِ شَهْرٍ



The Night of power is better
than a thousand months

سَلَامٌ هِيَ حَتَّىٰ مَطْلَعِ الْفَجْرِ

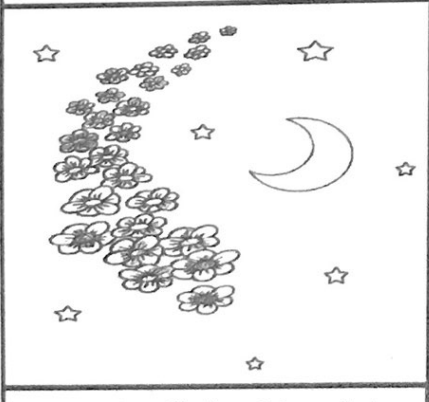

peace it is, till the rising of dawn

تَنْزِيلُ الْمَلَائِكَةِ وَالرُّوحِ فِيهَا بِإِذْنِ رَبِّهِمْ مِّنْ كُلِّ أَمْرٍ



in it the angels and the Spirit descend,
by the leave of their Lord,
upon every command

COLOR IN THE FLOWERS WHICH WILL BE HELPFUL
FOR US ON THE NIGHT OF QADR

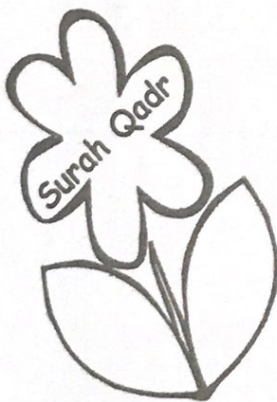
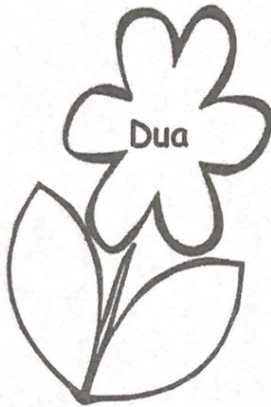

JOIN THE ARABIC ALPHABETS
TO SEE WHAT I AM!

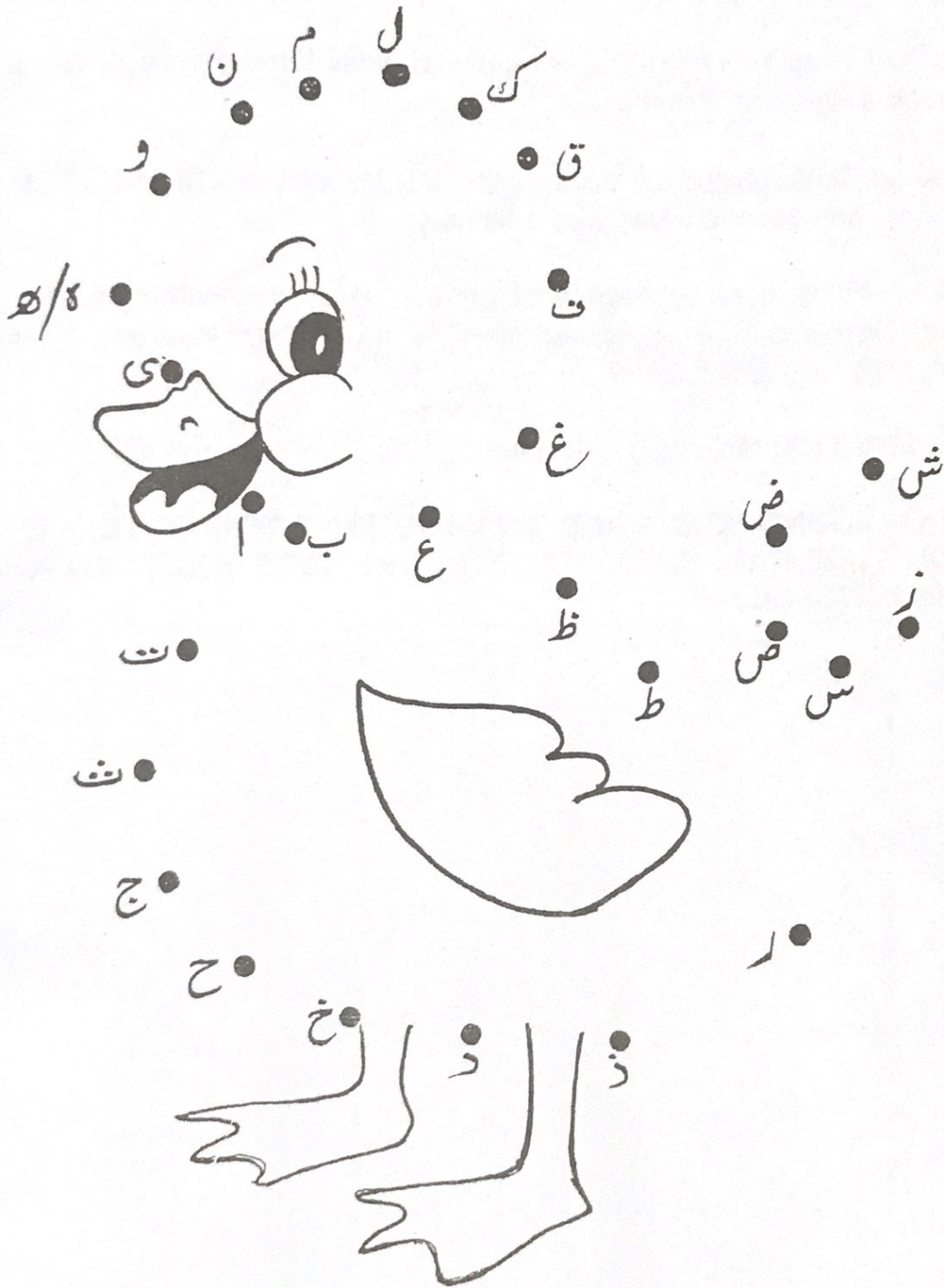

WIDAA RAMADHAN

"Mahdi, the month of Ramadhan is ending, we just have 3 more days to go, I am really going to miss it!" said Mahdiya sadly to her brother.

"Me too," replied Mahdi, "I am going to miss listening to all those beautiful Duas at the mosque".

"Also we have learnt so much from this blessed month and I feel much closer to Allah now", said Mahdiya.

"Well, let us make a promise to try our best to remain close to Allah always and to remember what we have learnt and use in our daily life", said Mahdi.

And Mahdi and Mahdiya tried their best to keep that promise.

DRAW ROUND YOUR HAND TO WAVE 'KHUDAHAFIZ' TO THE MONTH OF RAMADHAN AND JOIN THE DOTS BELOW TO READ THE MESSAGE.

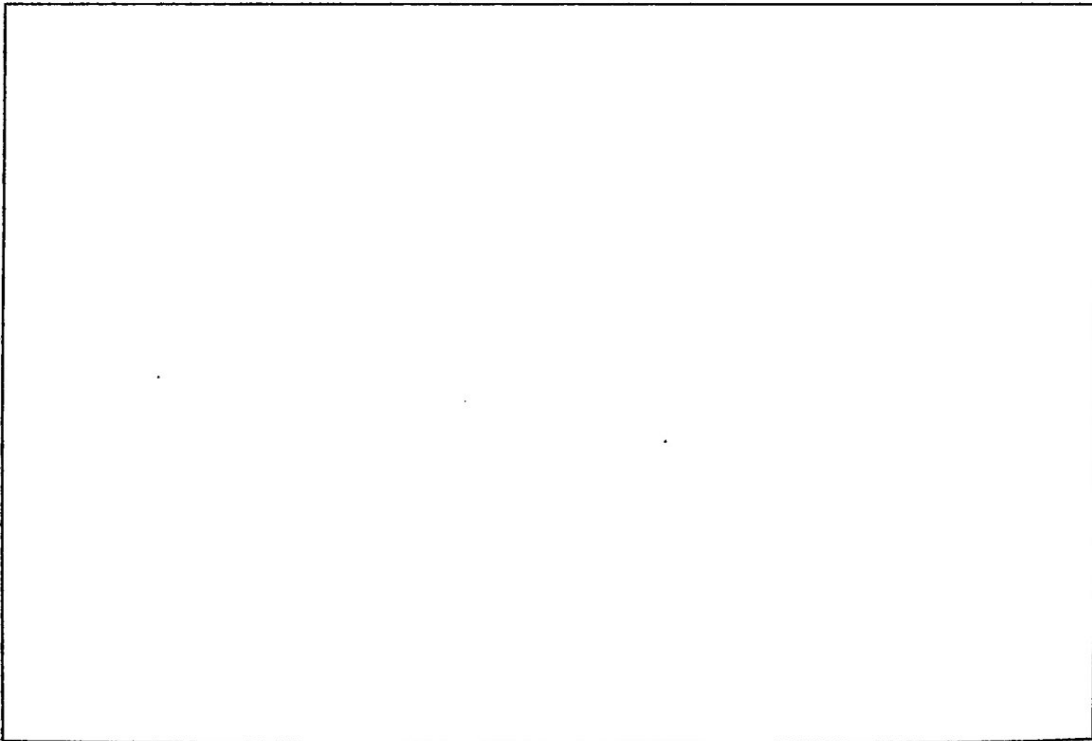

ALWIDAA YA RAMADHAN



EID MUBARAK!

Mahdi and Mahdiya are busy decorating their house with these beautiful lights!

Do you know why?
It's Eid Ul Fitr today!



Eid Ul Fitr marks the end of the Holy month of Ramadhan. 'Fitr' means to break and it means to break the fast and all other evil habits.

Imam Ali(a.s) says: "Eid is a day of happiness for those whose fasts and prayers have been accepted by Allah(s.w.t)".

Many people wonder why we celebrate Eid at the end of Ramadhan. Are we happy that Ramadhan has finished?
How can we be happy that such a great month of Allah, with all its blessings and mercies, has gone away?

The actual reason we celebrate Eid is not because we are glad the holy month is over, but because we are thankful to Allah for giving us the strength to fast and pray during Ramadhan.

The Holy Prophet(s.a.w.w) and our Imams celebrated Eid and encouraged all Muslims to do the following :



- 1) to perform ghusl of Eid
- 2) wear clean clothes, and put on perfume
- 3) go to the mosque to recite the Eid prayer
- 4) recite Ziarat of Imam Husayn and Dua-e-Nudba
- 5) exchange Eid greetings, visit each other, and pass the day joyfully.

Mahdi and Mahdiya wish all of you children "EID MUBARAK" and pray that all of your good deeds have been accepted by Allah(s.w.t)....
Inshallah!



WAKE UP! EID IS HERE!

Mahdiya woke up to the sound of her  _____.

She sat up in  _____ and rubbed her  _____s.

Mahdiya was very excited because it is Eid day.

Her family had spent the last few days preparing for Eid.



The Eid  _____ were ready. Mahdiya had made

Eid  _____ for her family and friends. She

had even made one for her  _____ Her

mother had baked many  _____ to serve on Eid.

She had bought Mahdiya a new  _____ to wear to the

Eid  _____. But Mahdiya also felt  _____

that Ramadhan was over. Saying goodbye to Ramadhan was hard

because it was so  _____.

COLOR THE GIFTS YOU WOULD LIKE TO RECEIVE FROM
YOUR MUM AND DAD ON EID IN RED AND BLUE.
NOW COLOR THE GIFTS WHICH YOU CAN GIVE TO
ALLAH IN YELLOW AND GREEN



Giving Sadaqa



Honoring Guests



New Dress



Reciting Dua



Sweets



Toys



Reciting Qur'an



Good Akhlaq